



T-1 LIGHTING

Project	Catalog #
Distributor	Type
Prepared by	Date

IGNITE LED HIGH BAY LIGHT

T1-IHBLED

The T1-IHBLED Optics AI series is part of the Ignite family of High Bay lighting that uses an optic lens to direct light at a 90° angle and is ideal for any industrial, commercial, or high ceiling retail facility. Highly efficient and meets DLC premium standards, it is available in 2 and 4 feet models in a variety of power options, and can be customized with motion sensors, battery pack, step-down, and other accessories.

T1-IHBLED 2ft.

Model Number	Input Power	Color Temp	Input Voltage	Lumens	Efficacy	Temp	CRI	PG
T1-IHBLED2/U/81-40	81	40	Standard 120-277V High Voltage 480V Optional	10814	134	-40°C ~ +40°C -40°F ~ +104°F	>80	IP 20
T1-IHBLED2/U/81-50		50		10846	134			
T1-IHBLED2/U/101-40	101	40		13140	130			
T1-IHBLED2/U/101-50		50		13231	131			
T1-IHBLED2/U/161-40	161	40		21461	133			
T1-IHBLED2/U/161-50		50		21671	135			
T1-IHBLED2/U/201-40	201	40		26170	130			
T1-IHBLED2/U/201-50		50		26311	131			

T1-IHBLED 4ft

Model Number	Input Power	Color Temp	Input Voltage	Lumens	Efficacy	Temp	CRI	PG
T1-IHBLED4/U/201-40	201	40	Standard 120-277V High Voltage 480V Optional	27296	136	-40°C ~ +40°C -40°F ~ +104°F	>80	IP 20
T1-IHBLED4/U/201-50		50		27376	136			
T1-IHBLED4/U/281-40	281	40		38693	138			
T1-IHBLED4/U/281-50		50		38834	138			
T1-IHBLED4/U/321-40	321	40		43816	137			
T1-IHBLED4/U/321-50		50		44073	137			
T1-IHBLED4/U/481-40	481	40		65368	136			
T1-IHBLED4/U/481-50		50		65752	137			

SPECS

WARRANTY: SEVEN YEAR PARTS AND FIVE YEAR LABOR





T-1 LIGHTING

IGNITE

LED HIGH BAY LIGHT

T1-IHBLED

ORDERING
OPTIONS

SERIES	FORM	WATTAGE	COLOR TEMP.	LENS	SENSOR	BATTERY BACKUP	ACCESSORIES	CONTROLS
T1-IHBLED	2	/U/201	50		MS	EM	AC	OS
T1-IHBLED	2 2ft. 4 4ft.	81 81W 101 101W 161 161W 201 201W 281 281W 321 321W 481 481W	40 4000K 50 5000K	[Blank] None	[Blank] None MS Motion Sensor	EM 15W 20W 30W	[Blank] None WG Wire Guard AC Aircraft Cables PK Pendant Mount Kit Hooks & Chains	OS Sensors DL Daylight harvesting sensor

T1-IHBLED 2ft.

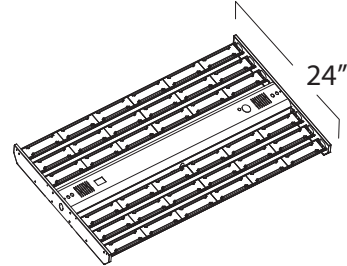
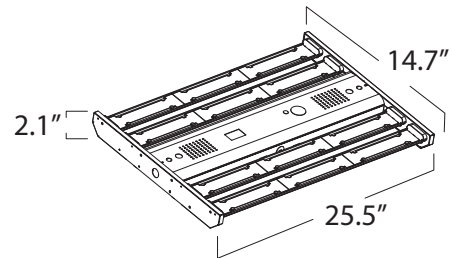
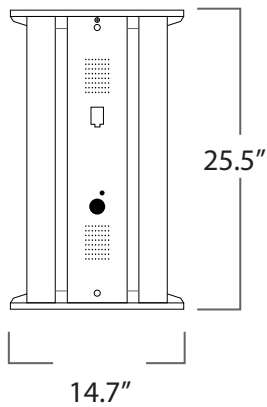

T1-IHBLED 4ft.

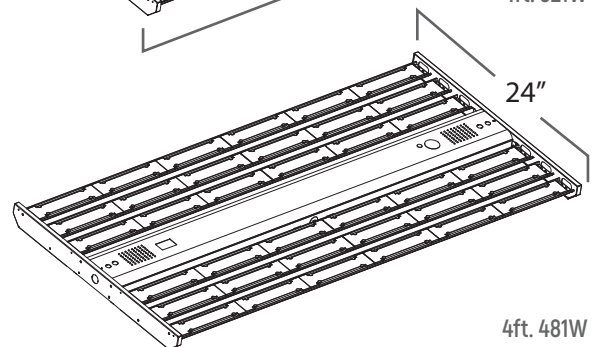
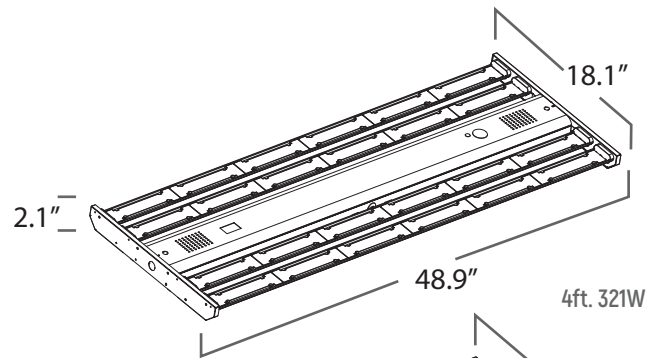
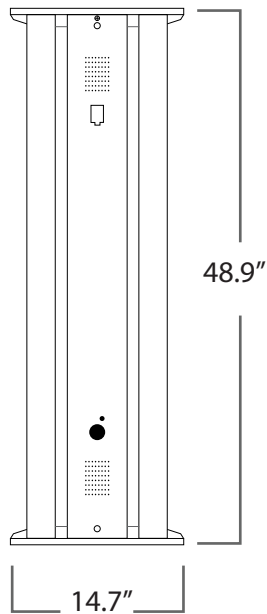

DIMENSIONS



T-1 LIGHTING

IGNITE

LED HIGH BAY LIGHT

T1-IHBLED

ACCESSORIES



V-Hook and Chain
(Included)



Aircraft Cable

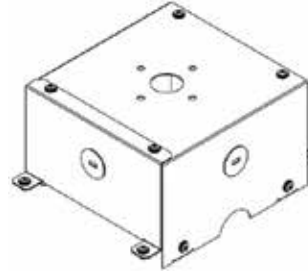

Perdent Mount Kit

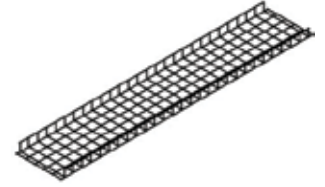

Wire Guard

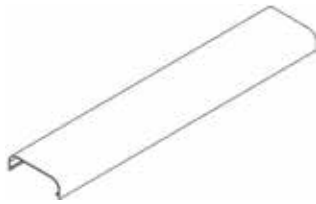

Lens / Cover



Optics

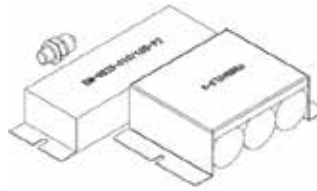

Backup Battery Pack



Motion Sensor
(Internal/External)

PHOTOMETRIC DATA 81W 2FT.

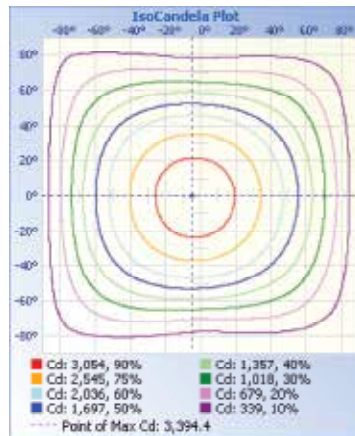

PHOTOMETRIC DATA

PHOTOMETRIC DATA 101W 2FT.

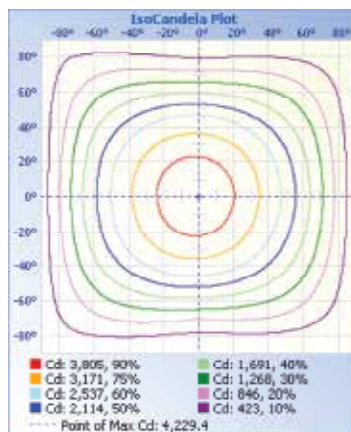
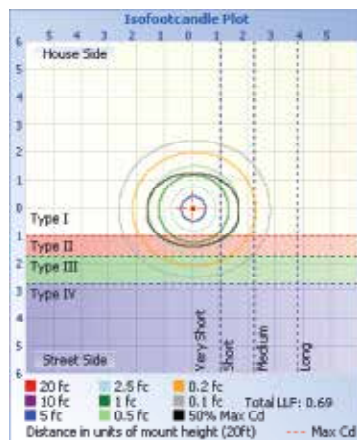

Illuminance at a Distance

Center Beam Fc	Beam Width
14.6 fc	44.5 ft 52.4 ft
3.66 fc	80.9 ft 104.0 ft
1.63 fc	133.4 ft 157.3 ft
0.91 fc	177.9 ft 209.7 ft
0.59 fc	222.4 ft 262.1 ft
0.41 fc	266.8 ft 314.5 ft

Vert. Spread: 105.2°
Horiz. Spread: 114.1°

PHOTOMETRIC DATA 161W 2FT.

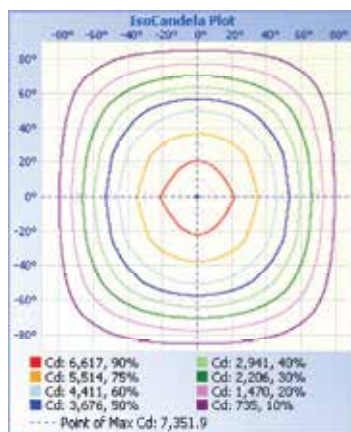
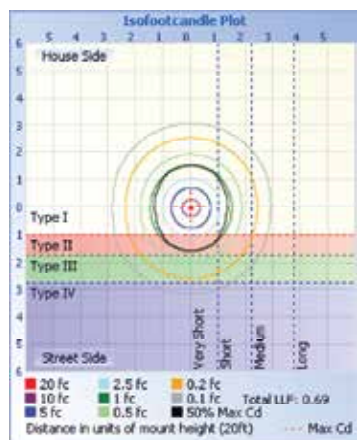

Illuminance at a Distance

Center Beam Fc	Beam Width
25.4 fc	52.5 ft 45.3 ft
6.36 fc	105.0 ft 90.6 ft
2.83 fc	157.5 ft 135.9 ft
1.59 fc	210.0 ft 181.3 ft
1.02 fc	262.5 ft 226.6 ft
0.71 fc	315.0 ft 271.9 ft

Vert. Spread: 114.1°
Horiz. Spread: 106.2°

PHOTOMETRIC DATA 201W 2FT

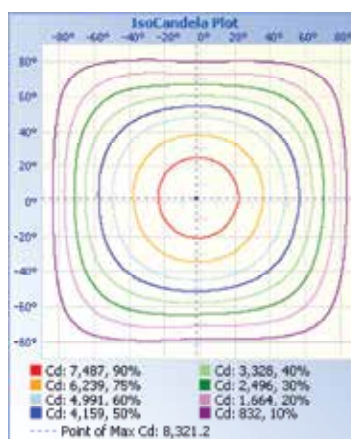

Illuminance at a Distance

Center Beam Fc	Beam Width
28.8 fc	45.0 ft 52.8 ft
7.19 fc	90.1 ft 105.7 ft
3.20 fc	135.1 ft 158.5 ft
1.80 fc	180.2 ft 211.3 ft
1.15 fc	225.2 ft 264.1 ft
0.80 fc	270.3 ft 317.8 ft

Vert. Spread: 105.9°
Horiz. Spread: 114.5°

PHOTOMETRIC DATA

PHOTOMETRIC DATA 201W 4FT.

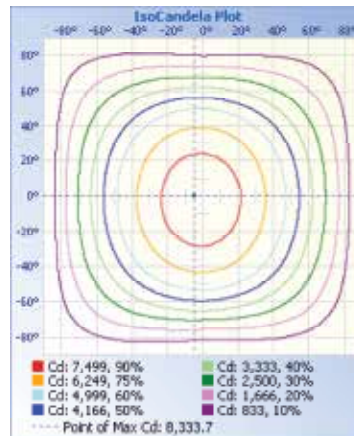
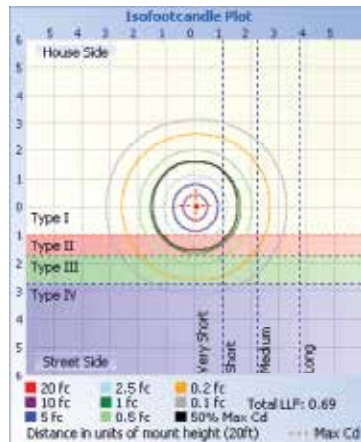

Illuminance at a Distance

Height	Center Beam fc	Beam Width
17.0ft	28.8 fc	53.9 ft 49.2 ft
34.0ft	7.20 fc	107.9 ft 98.4 ft
51.0ft	3.20 fc	161.8 ft 147.6 ft
68.0ft	1.80 fc	215.8 ft 196.8 ft
85.0ft	1.15 fc	269.7 ft 246.0 ft
102.0ft	0.80 fc	323.7 ft 295.2 ft

Vert. Spread: 115.6°
Horiz. Spread: 110.7°

PHOTOMETRIC DATA 281W 4FT.

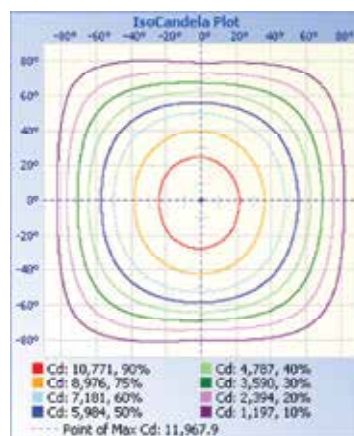
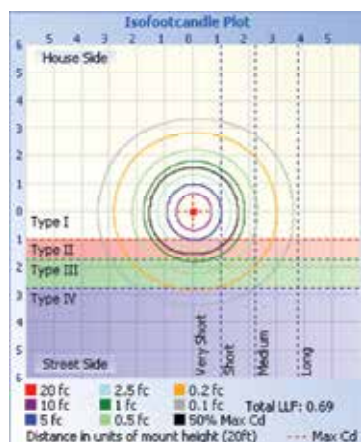

Illuminance at a Distance

Height	Center Beam fc	Beam Width
17.0ft	41.4 fc	52.9 ft 51.1 ft
34.0ft	10.4 fc	105.8 ft 102.1 ft
51.0ft	4.60 fc	158.6 ft 153.2 ft
68.0ft	2.59 fc	211.5 ft 204.3 ft
85.0ft	1.66 fc	264.4 ft 255.3 ft
102.0ft	1.15 fc	317.3 ft 306.4 ft

Vert. Spread: 114.5°
Horiz. Spread: 112.7°

PHOTOMETRIC DATA 321W 4FT.

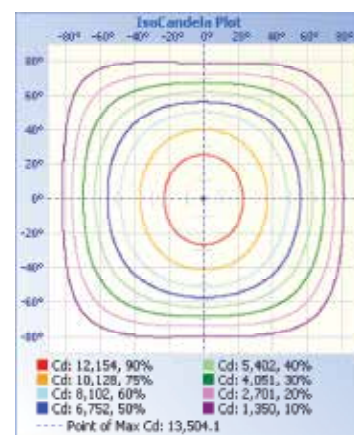
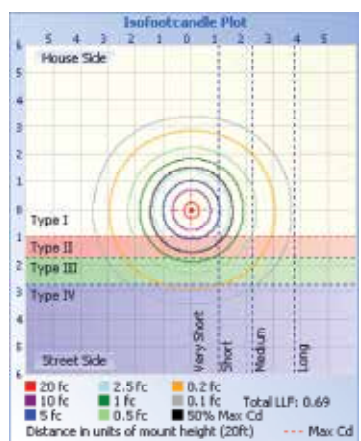

Illuminance at a Distance

Height	Center Beam fc	Beam Width
17.0ft	46.7 fc	52.2 ft 50.3 ft
34.0ft	11.7 fc	104.3 ft 100.5 ft
51.0ft	5.19 fc	156.5 ft 150.8 ft
68.0ft	2.92 fc	208.7 ft 201.0 ft
85.0ft	1.87 fc	260.9 ft 251.3 ft
102.0ft	1.30 fc	313.0 ft 301.5 ft

Vert. Spread: 113.8°
Horiz. Spread: 111.8°

PHOTOMETRIC DATA 481W 4FT.

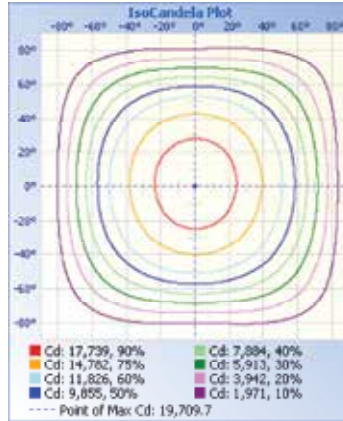
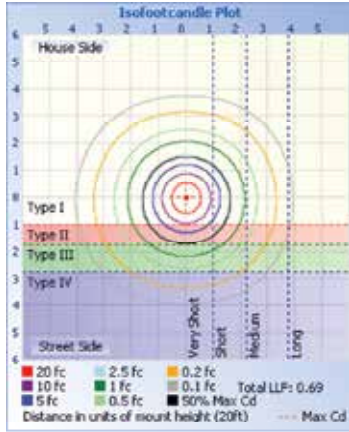

Illuminance at a Distance

	Center Beam Fc	Beam Width	
17.0ft	60.2 Fc	54.5 ft	54.0 ft
34.0ft	17.0 Fc	109.0 ft	108.1 ft
51.0ft	7.50 Fc	163.5 ft	162.1 ft
68.0ft	4.26 Fc	218.1 ft	216.2 ft
85.0ft	2.73 Fc	272.6 ft	270.2 ft
102.0ft	1.89 Fc	327.1 ft	324.3 ft

■ Vert. Spread: 116.1°
■ Horiz. Spread: 115.7°